

Ash Drawer Housing

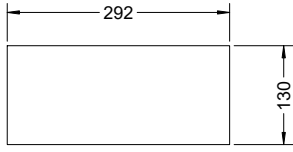

End Cap

Ash Drawer Front

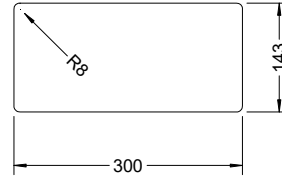

Ash Drawer Back

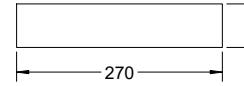

Back View

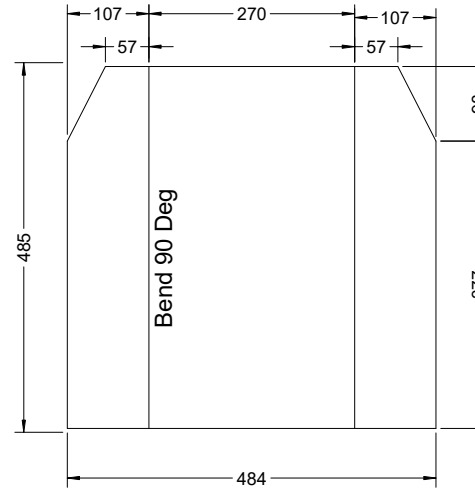
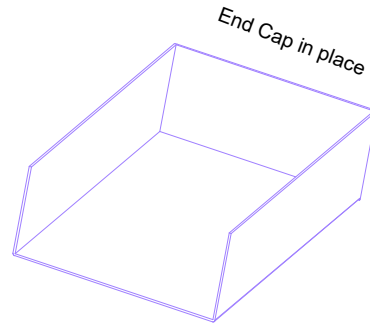
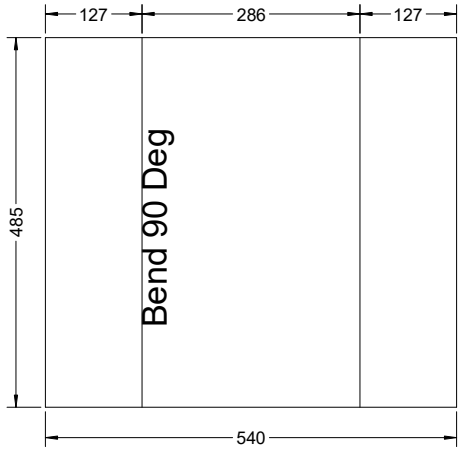
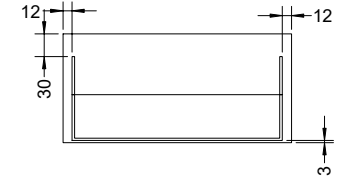

Bend the body and centre the front on the body. Weld on the inside.

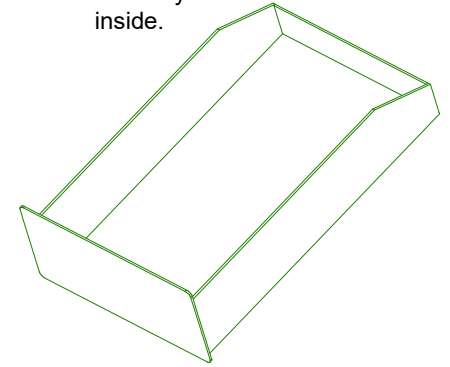

540 x 485 x 2 or 3 mm steel sheet

484 x 475

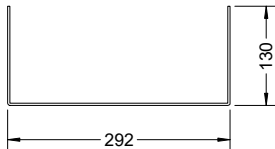

****Important****

The Ash Drawer Housing is mounted so the open end is flush with the end of the stove body. The drawer front must completely close air gaps so no air can enter around the ash drawer.

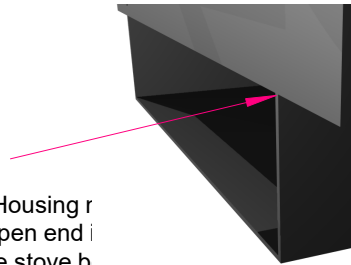

ASH DRAWER

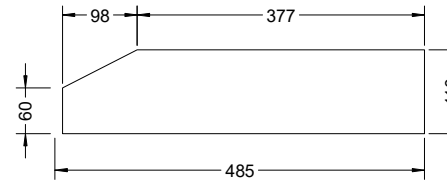

Add any suitable handle

Dwg. KG4.4.12.04

Model KG4 B
Version 1.2
13 Dec 2017

C Pemberton-Pigott